

**Kleuren / Farben / colors:**

H = Humbrol

R = Revell

\*\*\*\*\* = a lot

\* = a little

**GN - Green**

• H76\*\*33\*\* / R48\*\* + 8\*\*

**WH - White**

• H34 / R5

**NW - Natural Wood**

• H110 / R86

**SR - Scarlet Red**

• H60 / R36

**OR - Orange**

• H82 / R25

**ME - Metal**

• H53 / R68

**CE - Cement**

• H34\*\*\* + 33\* + 110\*

• R5\*\*\* + 8\* + 86\*

**RB - Rust Brown**

• H113 / R83

**LG - Light Grey**

• H64 / R75

**DG - Dark Grey**

• H79 / R77

**• Mengverhoudingen:**

\*\*\* = veel / viel / much

\*\* = evenveel / gleich / equal

\* = weinig / wenig / a little

• Lijm resin en messing onderdelen met secundelijm (cyanoacrylaat).

• Zum verkleben verwenden Sie Cyanoacrylate.

• Glue resin and brass parts with Cyanoacrylate.

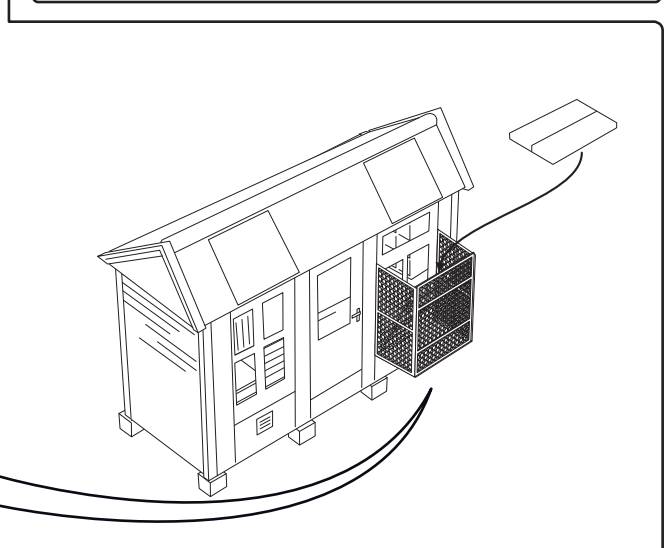
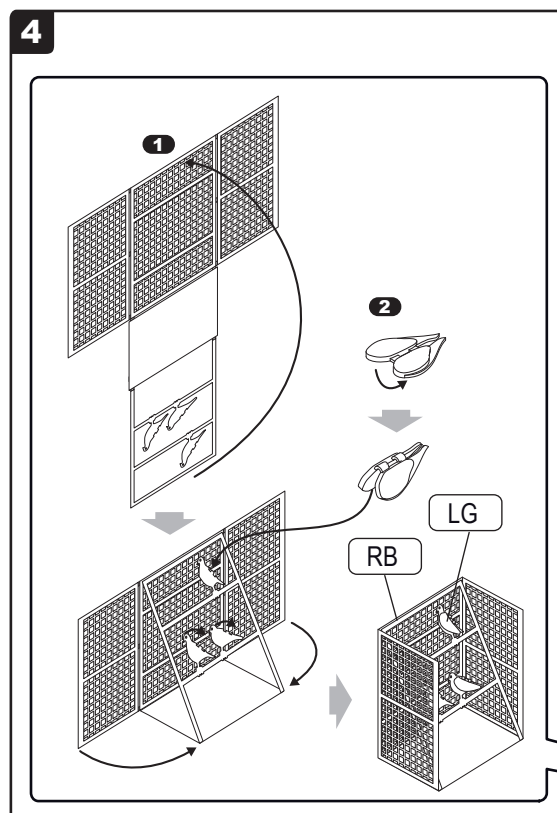
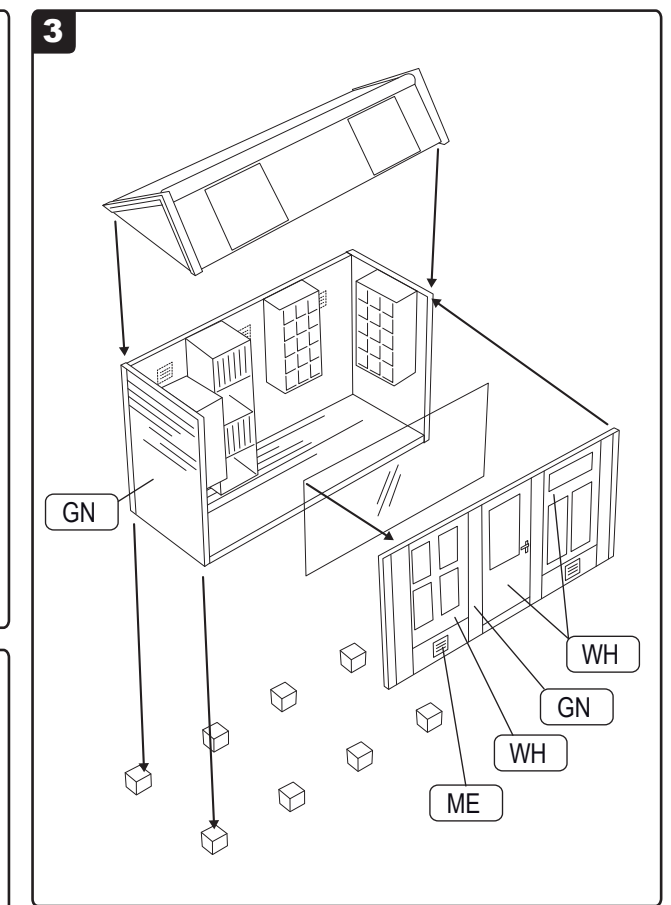
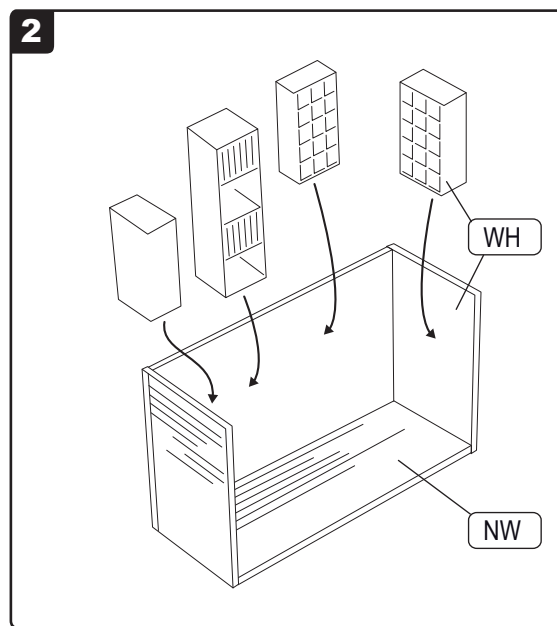
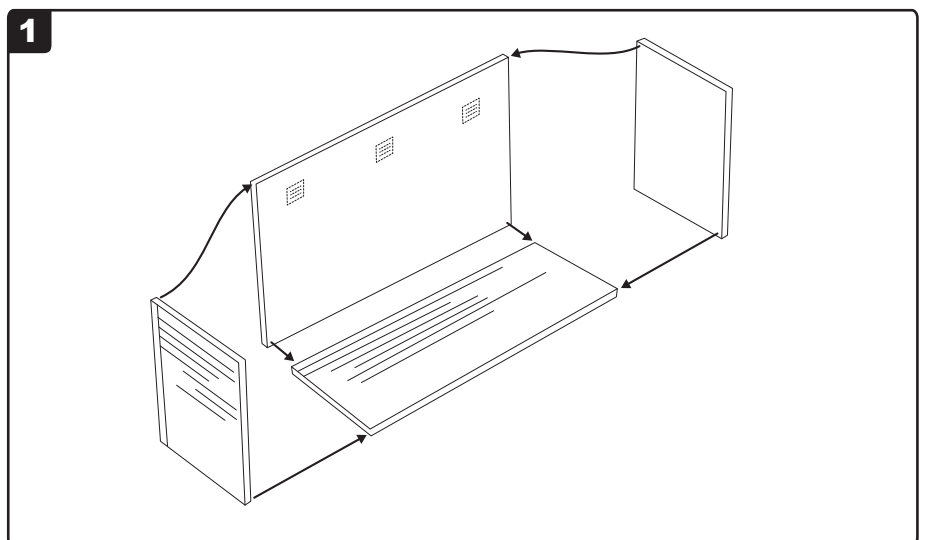
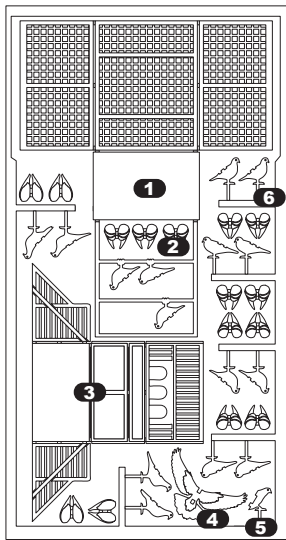

5

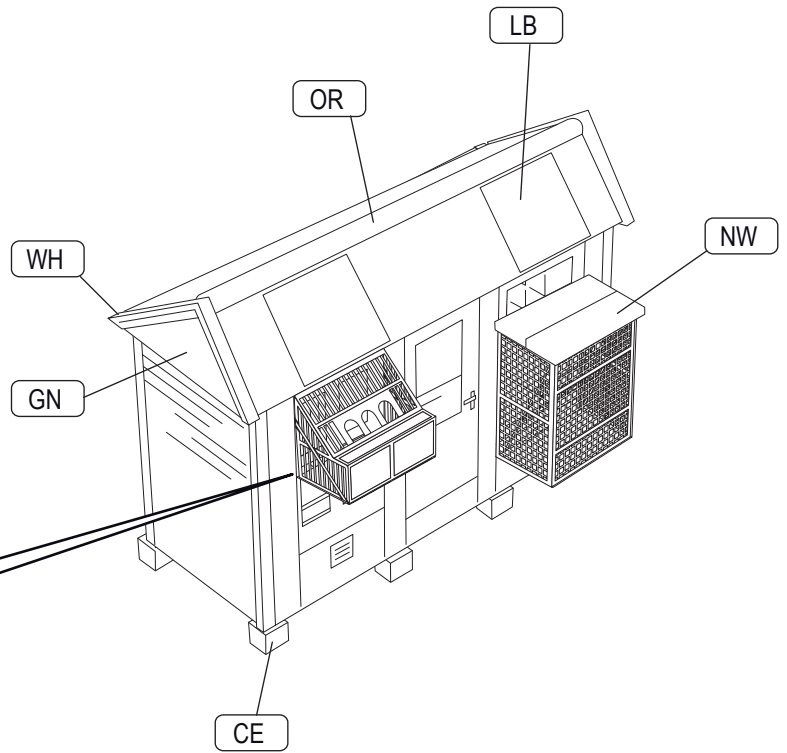
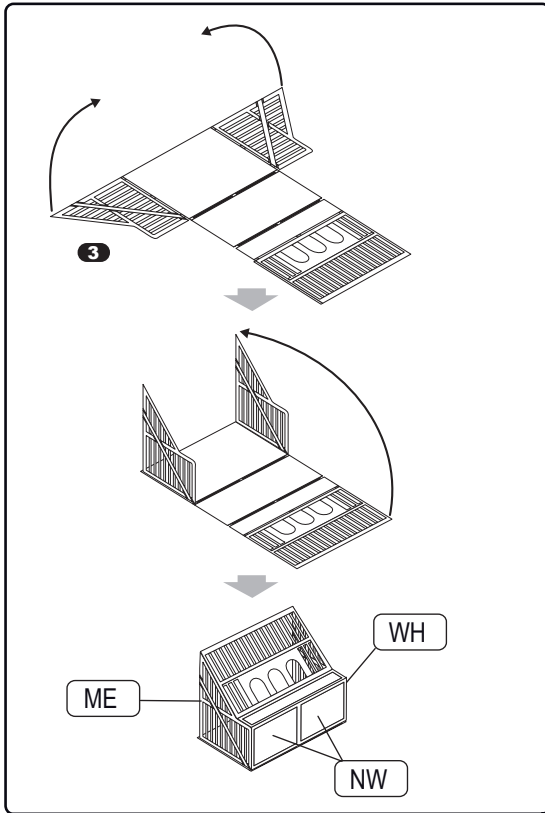

6

