

Kleuren / Farben / colors

H = Humbrol | R = Revell

H33	=	R9
H82	=	R30
H60	=	R31
H110	=	R85
H56	=	R91
H11	=	R99
H159	=	R68
H85	=	R9
H98	=	R85**+9**

Gelboliv:

H155	=	R42
------	---	-----

Flecktarnung:

H105	=	R65
H62+113	=	R84
H33***+H62*	=	R9

• Mengverhoudingen:

- *** = veel / viel / much
- ** = evenveel / gleich / equal
- * = weinig / wenig / a little

• Lijm resin en messing onderdelen met secundelijm (cyanoacrylaat).

• Zum verkleben verwenden Sie Cyanoacrylate.

• Glue resin and brass parts with Cyanoacrylate.

www.artitec.nl

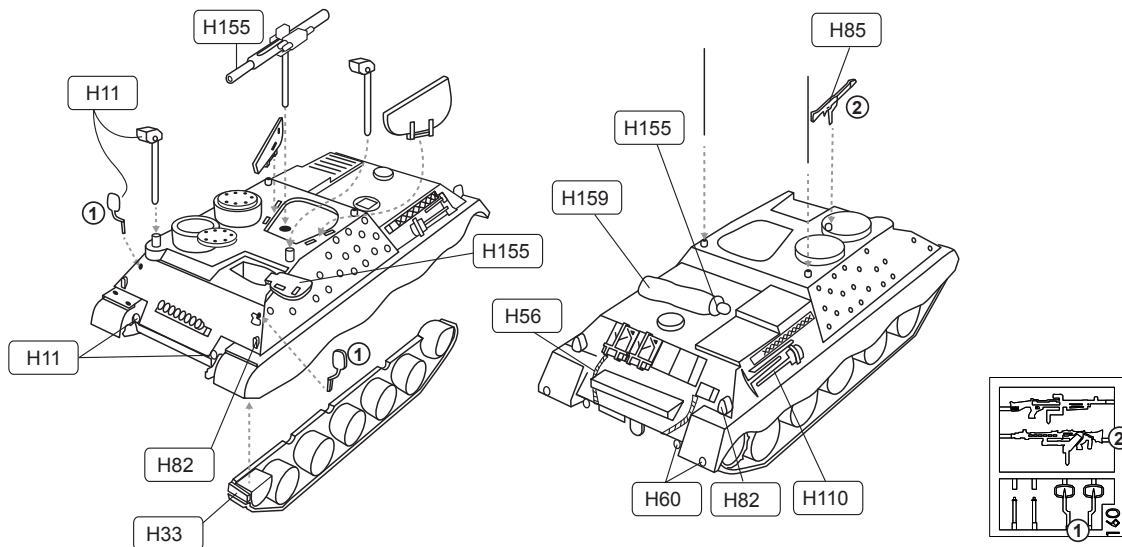

Kleuren / Farben / colors

H = Humbrol | R = Revell

H33	=	R9
H82	=	R30
H60	=	R31
H110	=	R85
H56	=	R91
H11	=	R99
H159	=	R68
H85	=	R9
H98	=	R85**+9**

Gelboliv:

H155	=	R42
------	---	-----

Flecktarnung:

H105	=	R65
H62+113	=	R84
H33***+H62*	=	R9

• Mengverhoudingen:

*** = veel / viel / much

** = evenveel / gleich / equal

* = weinig / wenig / a little

- Lijm resin en messing onderdelen met secundelijm (cyanoacrylaat).
- Zum verkleben verwenden Sie Cyanoacrylate.
- Glue resin and brass parts with Cyanoacrylate.

Tot / Bis / Until 1984

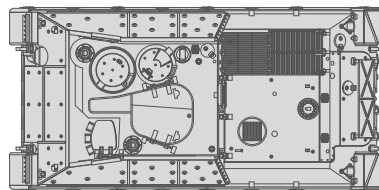
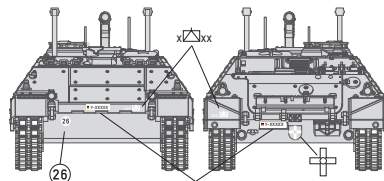
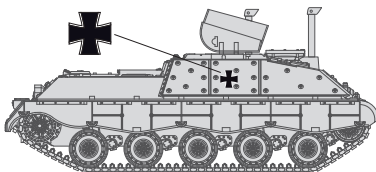
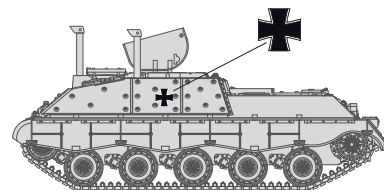

H155 / R42

Vanaf / Ab / From 1984

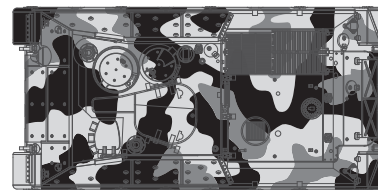
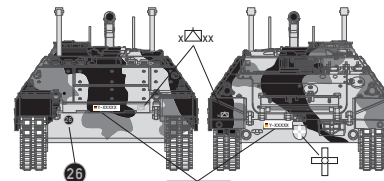
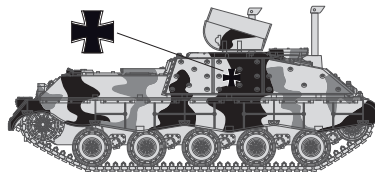
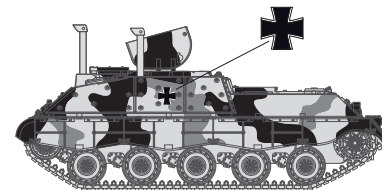

H105 / R65

H62***+113** (R84)

H33 / R9